

12 IR LED CMOS CAMERA

OPERATION / INSTALLATION MANUAL



TEC-112Q

DIMENSION

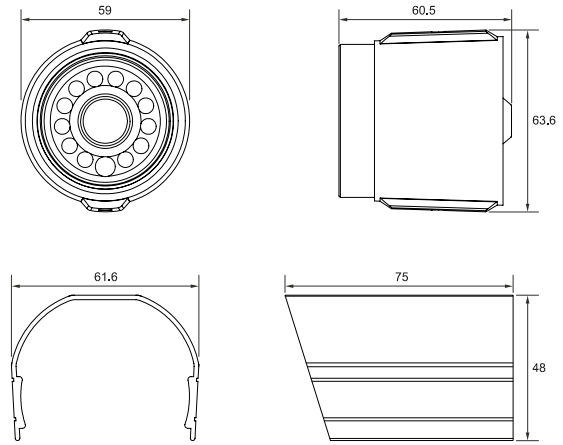

PRECAUTIONS

1. Recommend to use a regulated DC 12V power supply unit with camera for best picture and for safe operation of the unit. Unregulated DC 12V power supply usually provides around 10V~14V after loaded and can cause damage on the camera.
2. Recommend to use the camera with the monitor which has the standard video input impedance level of 75Ω. If in any case your monitor is set to high impedance mode, please switch the monitor standard impedance position. If the monitor does not have the impedance adjust switch, please ask us for a camera suitable for your monitor.
3. Do not attempt to disassemble the camera. There are no user serviceable parts inside.
4. Never face the camera toward the sun. It may cause a smear on the picture when the camera is directly faced to the sun or spot lights or lights reflecting objects.
5. When the IR LED camera is installation, the user should be operating the IR sensor in order to display normal color. Please fully cover the front glass by hand after power connection.

FEATURES

- 1/3" CMOS Image sensor
- 540TV Lines Horizontal resolution
- Excellent low light sensitivity of 0.1Lux/F1.2
- 12ea IR LED (Visibility range : 5~10m)
- True Day & Night
- Auto white balance
- Auto gain control
- Board lens f=3.6mm
- IP67 Weatherproof type
- All weatherproof anodized aluminum housing and sunshield

CAMERA COMPONENTS



Camera / Sunshield



Bracket



Screws

INSTALLING SUNSHIELD & CONNECTING CABLE

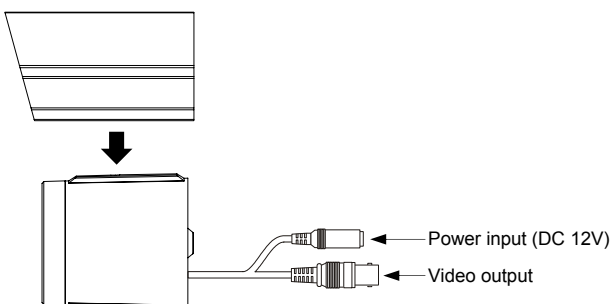

SPECIFICATIONS

TEC-112Q	
Signal Format	NTSC / PAL
Horizontal Resolution	540TV Lines
Image Sensor	1/3" CMOS Image Sensor
Total Pixels	762(H) x 504(V)
Effective Pixels	728(H) x 488(V)
Scanning System	2:1 Interlace
Synchronization	Internal
Scanning Frequency	15.734 KHz(H), 59.94 Hz(V)
Video Output	CVBS : 1.0Vp-p/75Ω
Min. Illumination	0.1Lux/F1.2
Iris Control	AUTO
Signal to Noise Ratio	More than 48dB
White Balance	AUTO
Gain Control	AUTO
Day & Night	AUTO (TDN)
Lens	Board Lens f=3.6mm
LED Quantity	12 EA
Input Voltage	DC 12V (±10%)
Power Consumption	LED Off : Max. 0.8W / LED On : Max. 2.3W
Operating Temperature	-10°C ~ +50°C
Operating Humidity	30% ~ 90% RH
Dimension	63.6(Ø) x 60.5(D)mm
Weight	Approx. 270g (W/Sunshield)